

HORIZON 3.5M SQUARE NON RETRACTABLE UMBRELLA - H35S

METRIC

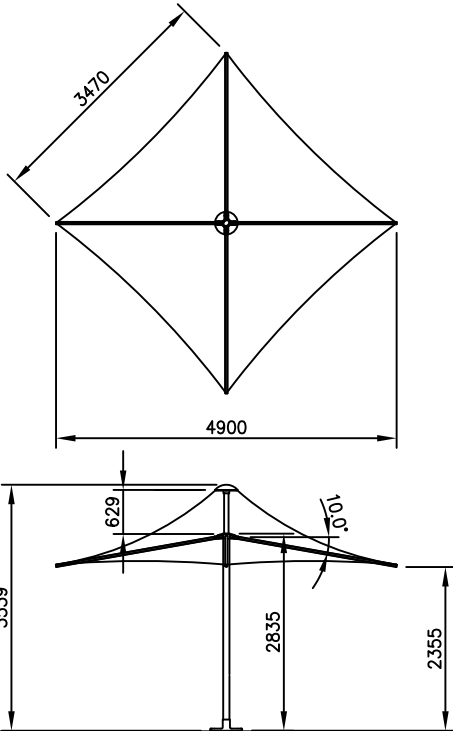

CODE: H35S
HORIZON 3.5 M SQUARE

IMPERIAL

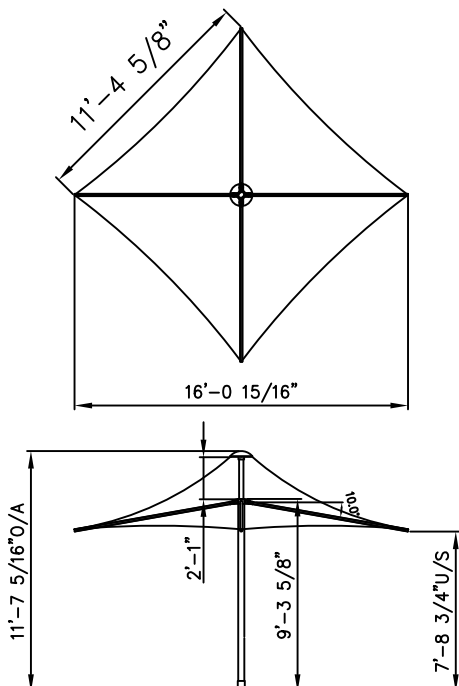

CODE: H35S
HORIZON 12 FT. SQUARE UMBRELLA

Specifications:

- Low maintenance, heat reflective, UV treated, fully welded membrane.
- Stainless steel edge cable for even tension of roof material.
- All metal work is Structural Aluminium or Stainless steel and powder coated.
- 10 year frame anti rust policy.
- 2 year warranty on the canopy.
- 5 year warranty on frame.
- Engineered wind rated 112 kph - 75 MPH (W33)

Options:

- Lighting
- Electric Heaters
- PVC Curtains
- Screen Printing
- Rain Lips
- Link panels joining umbrellas
- Electrical Access Point

